

## MV Agusta Brutale 800 Dragster/ Dragster RR High license plate holder



**Warning:** Before proceeding with the assembling of the product, MV Agusta specifies that the user is liable for any incorrect installation of the product or its improper use. We recommend the installation of the kit to qualified personnel

The colors and finishing of the parts have to be considered as indicative.

**DISASSEMBLING STANDARD LICENCE PLATE HOLDER PICTURES:**

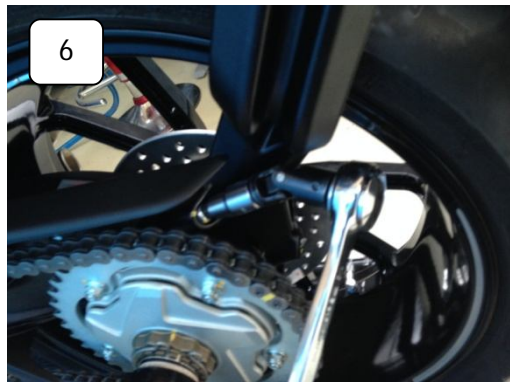
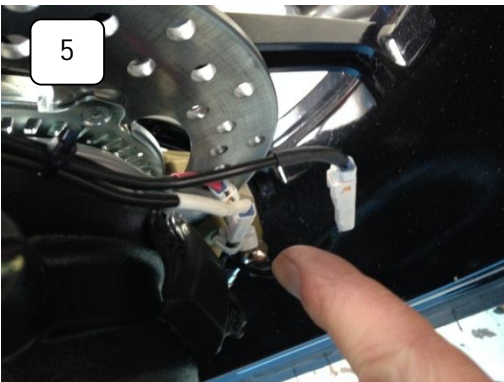
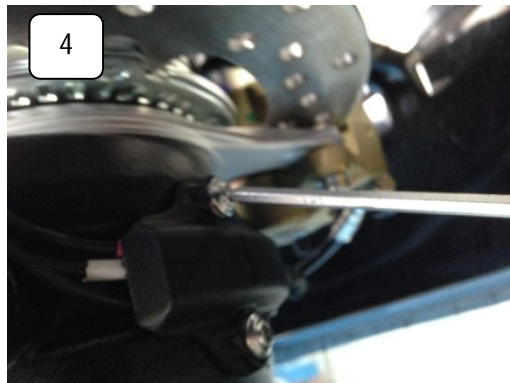
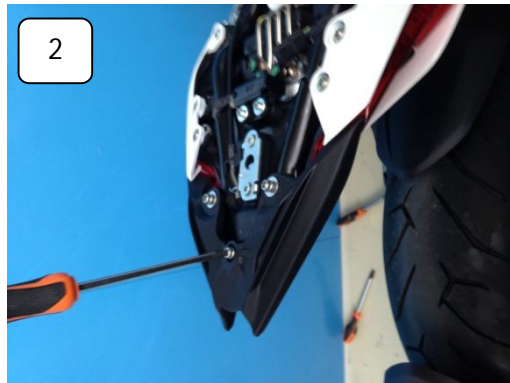
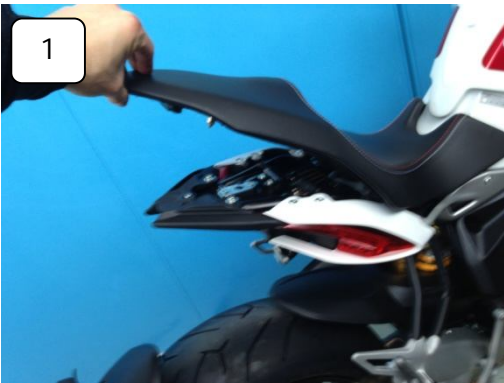

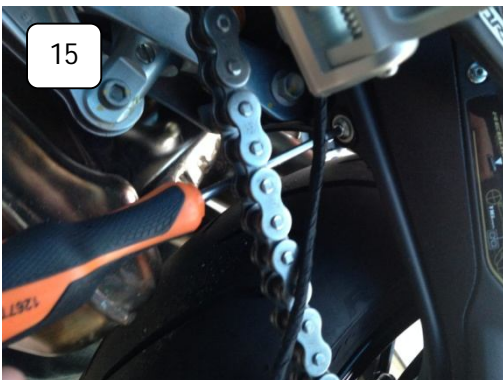
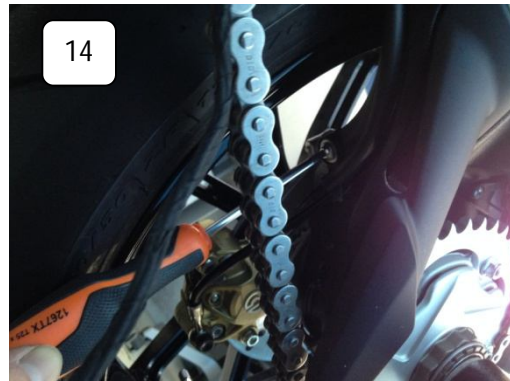
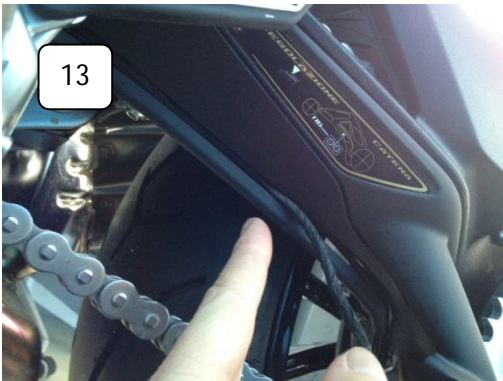
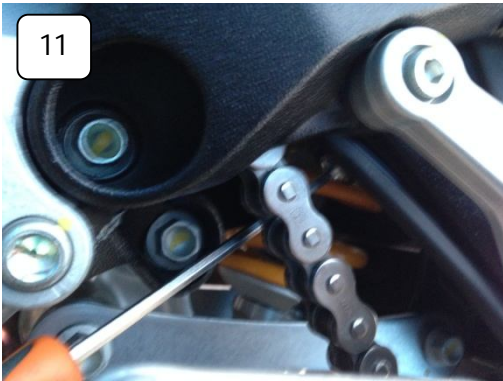
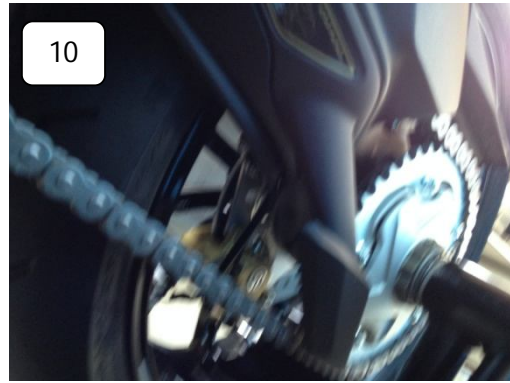
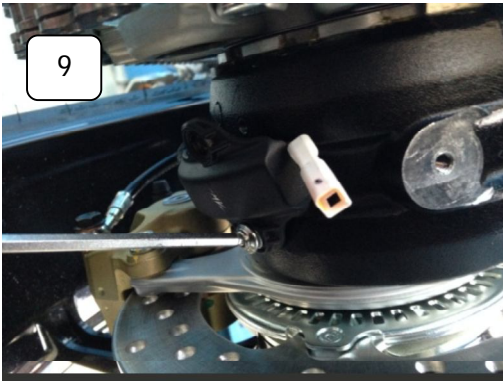

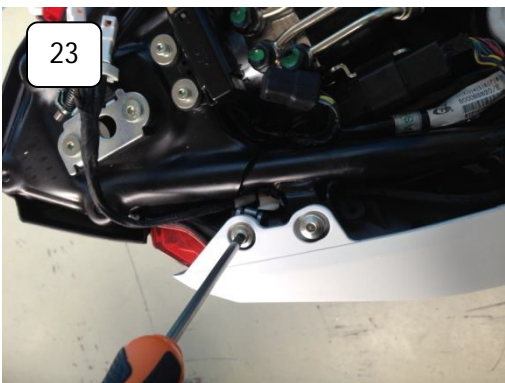
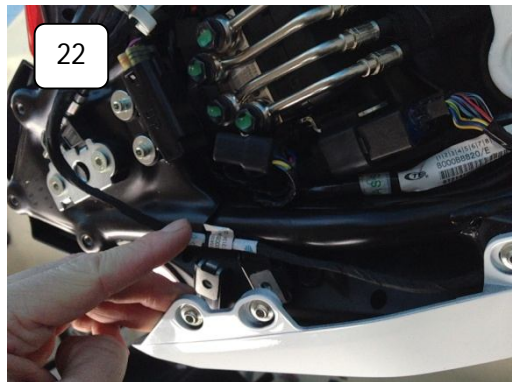
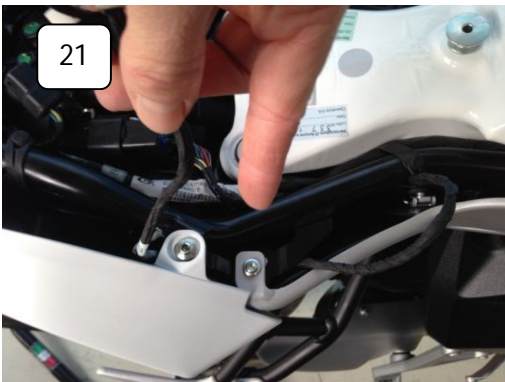
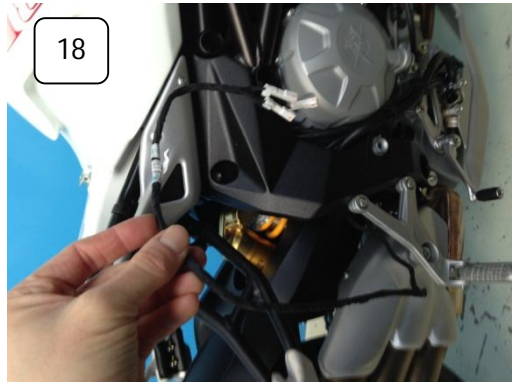

STANDARD LICENSE PLATE HOLDER MOUNTING PICTURES:



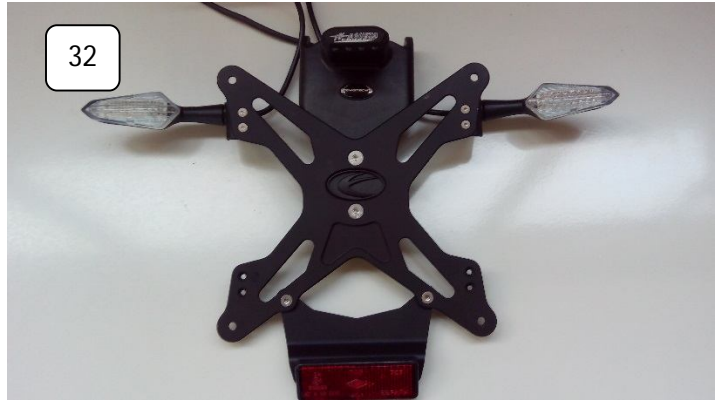

36b

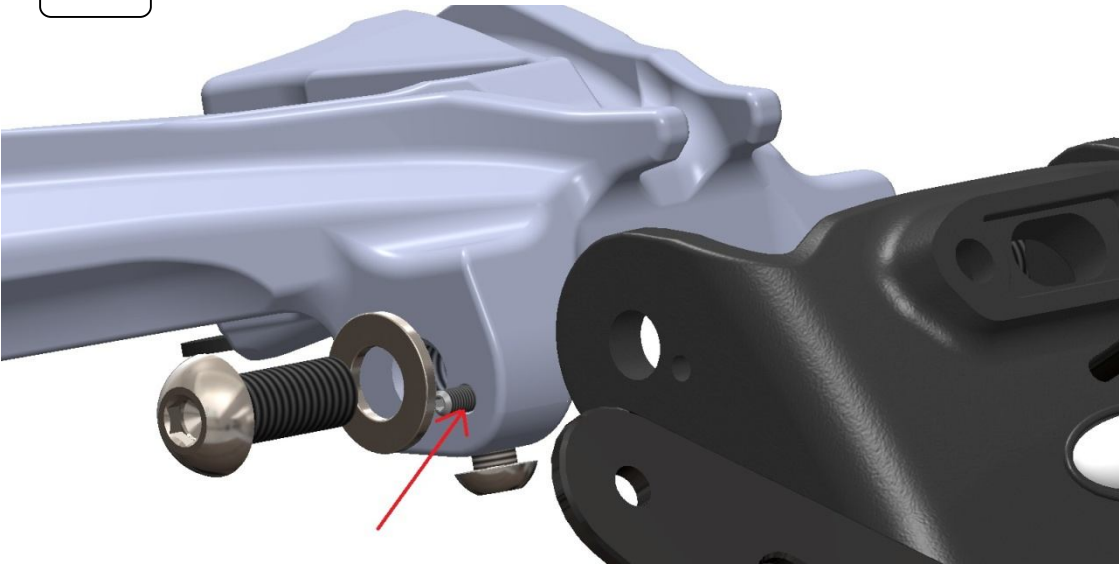

37



38



39



40



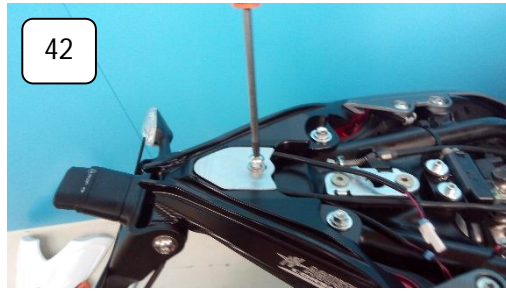

## ENGLISH

DISASSEMBLING STEPS OF THE STANDARD LICENSE PALTE HOLDER(refer to numbered images):



- 1) Lift and remove the bike's seat using the ignition keys.
- 2-3) Using a hexagonal 5 mm socket wrench unscrew the 3 fixing screws of the passenger grab rail, see pictures.
- 4) Loosen the plastic cover that includes electric connectors of the rear light device. It is located in the lower part of the swingarm.
- 5) Disconnect the electric connectors.
- 6-7) As shown in the picture, unscrew and remove the 3 screws that fix the license plate holder to the swing arm.
- 8) Remove the license plate's support.
- 9-15) Following the pictures remove the plastic cover that includes the electric cables, unscrewing 3 screws. Take out only the electric cables and assemble again all the parts checking that cables and pipes are well fixed.
- 16) Remove the electric cables behind the swingarm.
- 17-20) Put the electric cables in the under-seat compartment and fix it properly with plastic straps.
- 21-23) Unscrew the screws in the picture, move the fairing of the bike and put the electric cables in the under-seat compartment fixing it properly with plastic straps. Fix the fairing again with screws.

**ASSEMBLING STEPS OF THE AFTERMARKET LICENSE PLATE HOLDER (refer to the numbered pictures):**

- 24-25) Assemble the license plate light on the plastic part as shown in the picture and use the screws M5x35mm.
- 26-27) Assemble the indicators lights supports on the number plate's support, using the (4pcs) M3 bolts, as shown in the pictures.
- 28) Assemble the rear reflector on the dedicated support placing the washer and fastening the M5 hexagonal bolt.
- 29) Assemble the rear reflector support on the number plate's support using the (2pcs) M5 bolts included in the kit.
- 30) Check the correct tightening of the screws that fix the plate holder.
- 31) Connect carefully the indicators lights up the support paying attention to set the logo upwards, see picture.

- 32) Assemble and fix both the indicators lights and set the direction of the light to about 30° according to the license plate holder support.
- 33) Put the electric wirings in the rubber included in the kit, as indicated in the picture
- 34) Put the electric cables in the proper unit of the new license plate holder, see picture.
- 35) Block the mudguard rubber through dedicated M5 screws in order to seal the hole of the electric cables, see picture.
- 36a-36b) Using M8 screws and M8 washers fit the plate support to the aluminum bracket. Make the fixing of M8 screws only in paragraph 44. Insert the M3 x10 dowel pin that will set the inclination to 30°(see Annex 2).
- 37) Put the electric cables in the dedicated unit on the higher part of the license plate holder. Insert the electrical resistors included in the kit.
- 38) Cover the cables compartment with the dedicated cover and fix the screw with washers (see Annex 2)
- 39) Insert the two rubber washers in the screw used in step 38, under the aluminum frame (see images and Annex 1)
- 40) Put the new license plate holder on the frame of the bike paying attention to place it properly using these specific holes.
- 41) Set and screw the two standard screw and washers, you removed during the license plate holder disassembling.
- 42) Tighten the M6 screw of the cables unit on the bike's frame.
- 43) Check (adjust) the 3mm dowel pin that sets the inclination's angle of the license plate holder. It has to be 30° respect to the ground, (in accordance with rules of the road).
- 44) Fix the M8 screws as shown in the picture.
- 45) Link the electrical connections using the connectors integrated on the devices, insert the electrical resistors in the indicators lights wiring and check the correct flashing of the light.**
- 46) Place the electrical wiring in the under-seat unit and fix the cables with plastic straps in order to avoid damages due to vibrations. Check they don't obstruct the seat closure.
- 47) Set again the positioning of the seat and check the correct closure.
- 48) The license plate holder is compatible with the passenger seat cover.

Seal the M6 hole on the swingarm with the rubber cap provided(pos.4 Annex 2).

Place the new M12 screws and fasten them. **RESPECT THE TIGHTENING TORQUE OF THE NEW SWINGARMSCREWS**(available on the maintenance documents).

Check there are no wiring hanging from the swingarm.

Check the complete and correct tightening of the bolts.

EXTRA ACCESSORIES:

MV-ELT-001-B led light

MV-SF-01-B turn signals

MV-K-RES-6W resistors



Figure 1



Figure 2



**Figure 3**



